

25 GAUGE STEEL PAN DOOR

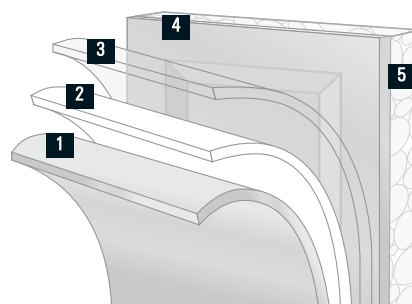

16' x 7' BuildMark, Colonial in White with Plain Colonial Windows

Defined raised panel styling combines with an authentic woodgrain texture to give your garage door curb appeal with BuildMark™ garage doors. The clean lines of colonial, ranch or flush panels add charm in an economically priced pan or insulated door. Or choose the carriage house option for a distinctive look.



- 1 Baked-on Finish
- 2 Epoxy Primer
- 3 Galvanized Layer
- 4 High-Strength Steel
- 5 Polystyrene Insulation Option

BuildMark™ sections are constructed from high-strength, rust-resistant galvanized steel and are coated with a baked-on polyester paint finish for extended life. BuildMark also offers an optional layer of polystyrene insulation for additional thermal efficiency.

WARRANTY:

Sections*: Limited Lifetime (Rust-Through) — Hardware/Springs: 1-year

WWW.RAYNOR.COM

*See full warranty details, available at www.raynor.com

Hardware

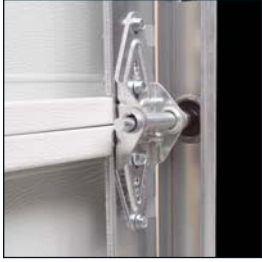

Track formed from strong galvanized steel, paired with durable, long-wearing steel rollers ensures smooth, quiet operation.

Insulation



An energy-saving core of polystyrene insulation provides added comfort and helps keep your garage quieter.

Section Joints



Strong, roll-formed tongue-and-groove meeting rails seal out wind, rain, and snow, keeping your garage dry and secure.

Authentic Woodgrain



Authentic woodgrain texture on the door's exterior adds visual appeal.

Carriage House Panel Option



The Carriage House panel option offers a maintenance-free carriage house design in a steel pan door. Add character to your door with attractive decorative face hardware in either Bean or Fleur-de-lis handles or straps.

Decorative Hardware

The black matte powdercoated straps and handles are designed to appear hand-forged, adding a historically-accurate dimensional quality to your door. Choose from handles and straps with Bean or Fleur-de-lis designs.



Bean Handles



Bean Strap



Fleur-de-lis Handles



Fleur-de-lis Strap

SIZES

Heights: 6'6" through 10' in 3" increments*

Widths: 6', 8', 9', 10', 12', 15', 16', 18'

* 7'3" height not available

PANEL STYLES*



1-Car Colonial



2-Car Colonial



1-Car Ranch



2-Car Ranch

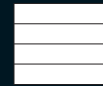

1-Car Flush

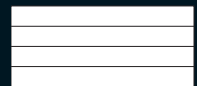

2-Car Flush



1-Car Carriage House



2-Car Carriage House

*1-car doors shown in 8' x 7' configuration; 2-car shown in 16' x 7'.

COLORS



SNAP-IN WINDOW STYLES**



Clear Ranch

Available for colonial



Stockbridge Ranch



Sunburst Colonial



Sunburst Ranch



Stockton Colonial



Stockton Ranch

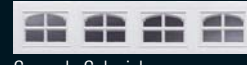

Cascade Colonial

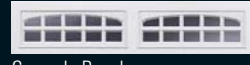

Cascade Ranch



Sherwood Colonial



Cathedral Colonial

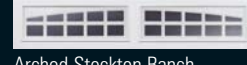

Arched Stockton Ranch

Available for ranch & carriage house options



Prairie Ranch



Sunray Ranch*

**Not all window styles are shown. Please consult your Raynor Dealer or see + the Raynor Decorative Windows literature for more options.

Windows are shown in 1-car configurations, except Sunray Ranch.

RAYNOR

800-4-RAYNOR (472-9667)

www.raynor.com

P.O. Box 448, 1101 East River Road • Dixon, IL 61021-0448