

AFFINA™

# Raynor Innovations Series™

THE ULTIMATE IN DESIGN CHOICES

PREMIUM◆3-LAYER CONSTRUCTION  
STEEL • INSULATION • STEEL

# DURABILITY



8' x 7' Affina Colonial in White with  
Dimensions Regency Black Colonial Windows



# STYLE

# SAFETY



# Affina™

PERFECT ELEGANCE

The flagship model of Raynor Innovations Series™ is the elegant Raynor Affina. Beautiful and strong, only Affina doors feature the EnduraCote™ Hardware System.

Affina doors are available in 3 standard and 11 optional door designs. Please see pages 6-7 for design choices.

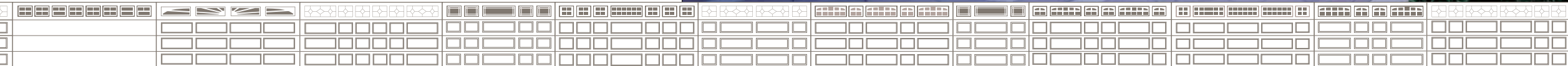

8' x 8' Affina Millcreek (left) and 16' x 8' Affina Edgewater (right) in Almond

2"	18
THICK	R-VALUE

## 2" Thick Sections

Affina's 2" thick door sections are made from strong, rust-resistant, 24-gauge embossed galvanized steel and are coated with a baked-on polyester paint finish for long life.

1. Baked-on finish
2. Epoxy primer
3. Galvanized layer
4. High-strength steel
5. Polyurethane insulation
6. High-strength steel

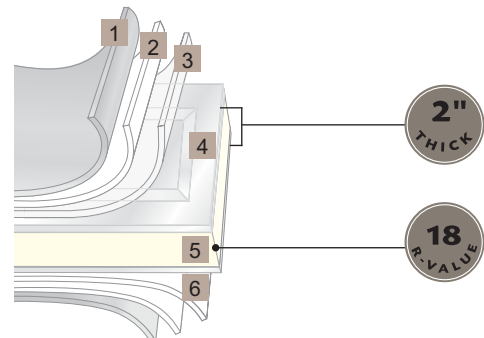

## Colors

Standard

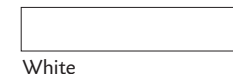

White



ClayTone



Almond

Optional



GrayTone



Brown\*



Hunter Green\*

\*Features the Kynar® paint process, which provides extended UV protection against fading.

## EnduraCote™ Hardware System



The EnduraCote™ Hardware System, comes with extended-life springs, track and hardware that are powdercoated to provide a clean, finished look and maximum protection against rust. Nylon rollers with steel ball bearings also help to provide superior noise reduction.

## Carriage House Panel Option



Colonial embossments are spaced for a carriage house look. Add optional decorative hardware to complete the look. See page 7 for details.

## Premium Warranty

Door Sections: "For As Long As You Own Your Home" against rust

Hardware/Springs: "For As Long As You Own Your Home"

# AFFINA™

# Affina Features

BUILT TO BE WORRY FREE



18' x 7' Affina Highcrest with the EnduraCote™ Hardware System and Cascade Colonial and Ranch Snap-In Windows

**Insulation**, through our innovative process, fills 100% of the door's interior space. The energy-saving polyurethane core delivers an exceptional 18 R-value and helps to reduce noise.

**Thermal protection**, provided by a continuous thermal break (A), prevents heat loss and metal-to-metal contact between inside and outside surfaces. An air seal (B) blocks airflow between sections.

**Finger protection** is important to today's homeowner. As your door closes, the exclusive Raynor Finger Protection System™ gently pushes fingers away from section joints.

## ENDURACOTE™ HARDWARE SYSTEM

1 **EnduraCote™ springs** are powder-coated black for rust-resistance and longer life. Springs are designed to precisely match each door's weight for proper balance.

2 **EnduraCote™ track** is powdercoated white for smoother operation and a finished appearance. Track is adjustable so the door always fits tightly against the door opening, preventing energy loss.

3 **Nylon rollers with steel ball bearings** are included in the EnduraCote™ Hardware System and provide superior noise reduction – a plus when living space is in close proximity to the garage.

4 **Door sections** are constructed from hot-dipped galvanized steel and coated with a baked-on, fade-resistant polyester finish for maximum durability, rust-resistance and color retention.

5 **Vinyl weatherseal** along the bottom helps keep out wind and rain while an optional perimeter weatherseal creates a seal along the exterior top and sides of the door.

6 **Cable attachments** prevent accidents and injuries. The tamper-resistant counterbalance cable attachment cannot be released while the cable is under tension.

7 **Hinges**, made of high-quality steel, feature an attractive, low-profile design and are powdercoated white to provide maximum protection against rust.

# Decorative Windows

THE ULTIMATE IN ELEGANCE

## Dimensions

### Frosted Beveled Glass with Caming



Diamond Silver Colonial  
available in Silver, Umber and Black



Expressions Silver Colonial  
available in Silver, Umber and Black



Antique Umber Ranch  
available in Silver, Umber and Black



Oval/Diamond Silver Ranch  
available in Silver, Umber and Black



Regency Black Colonial  
available in Silver, Umber and Black

### Frosted Beveled Glass



Diamond Colonial



Diamond Ranch



Prairie Colonial



Prairie Ranch



Chained Hexagon

### Clear Beveled Glass



Diamond Colonial



Diamond Ranch



Prairie Colonial



Prairie Ranch



Chained Hexagon

## Snap-In Styles



Stockbridge Ranch



Prairie Ranch



Stockton Ranch



Stockton Colonial



Cascade Ranch



Cascade Colonial



Sunburst Ranch Ranch



Sunburst Colonial



Sherwood Colonial



Cathedral Colonial



Arched Stockton Ranch



Sunray Ranch

## Caming

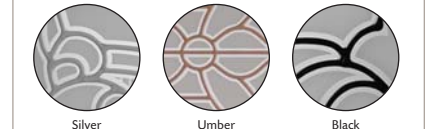

## Clear And Obscured



Clear Ranch  
available in Ranch or Colonial



Obscured Ranch  
available in Ranch or Colonial

Note: Windows are shown in one-car configurations, with the exception of Sunray Ranch.

# Door Designs

ELEVATIONS AND SIZES

## Sizes

Heights: 6'0", 6'3", 6'6", 6'9", 7'0", 7'6", 7'9", 8'0" Widths: 4'0" – 20'0"

## STANDARD

Affina doors come standard with these door designs.

### Colonial

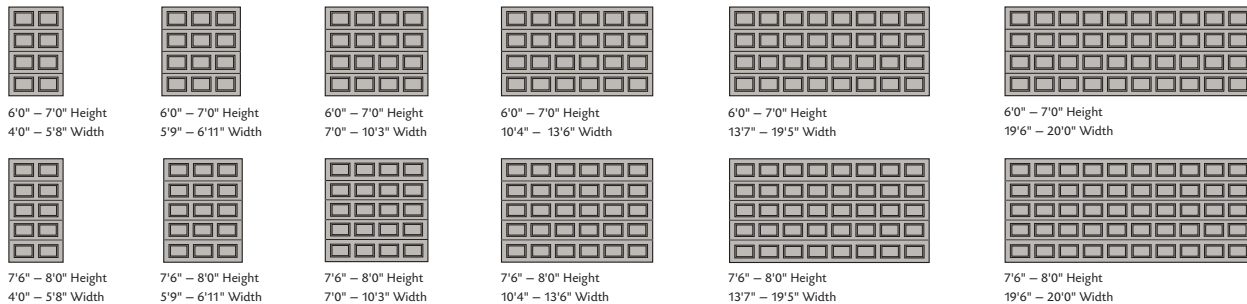

### Ranch

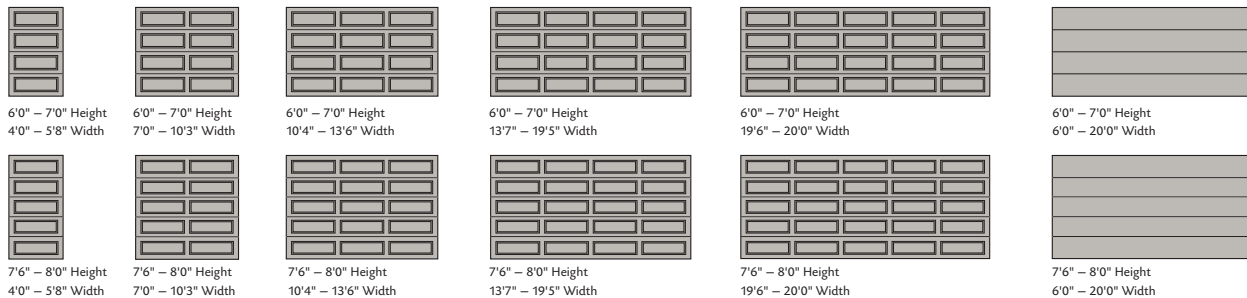

### Flush

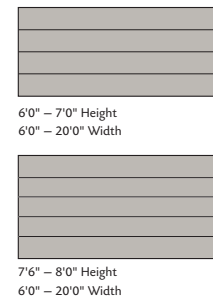

## OPTIONAL

Affina doors may be upgraded with these optional door designs.

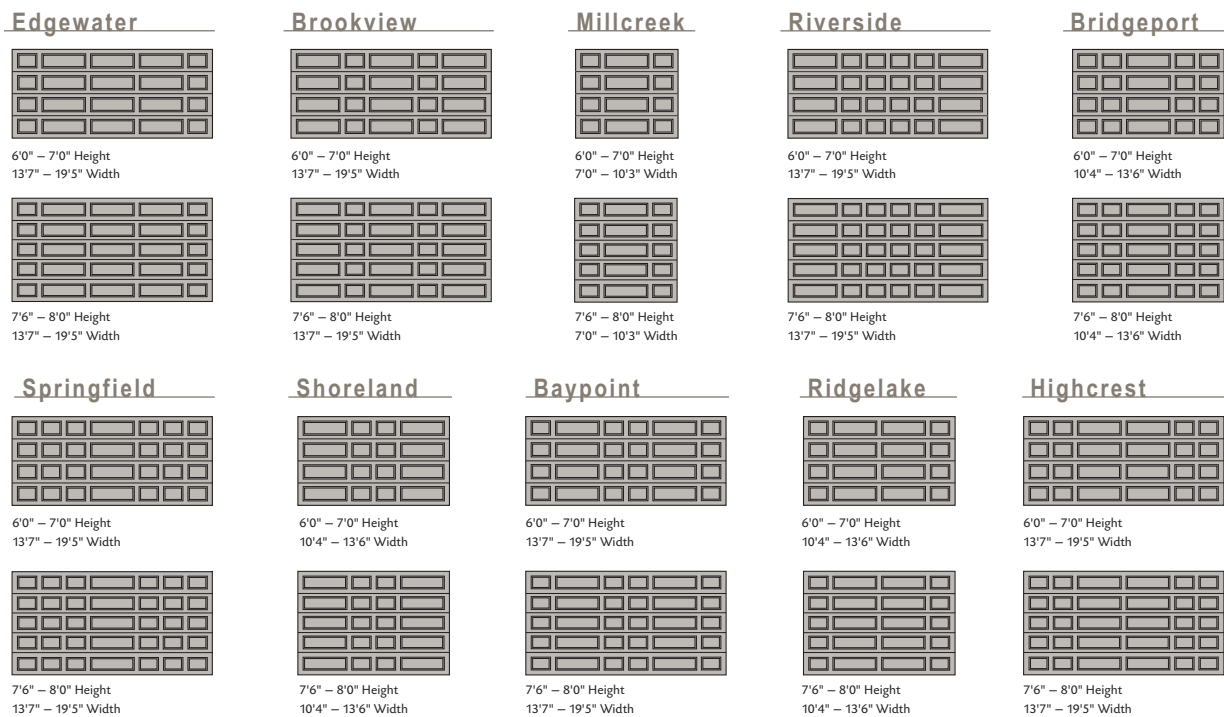

Note: Doors shown at standard sizes, actual appearance may vary.

# Carriage House Panel Option



8' x 7' Affina Carriage House option in ClayTone

Capture the look of a carriage house door in a maintenance-free, energy-efficient design with the carriage house option. The carriage house option offers finger-protection and an 18.0 R-Value.

## Panel Sizes

Carriage House Option is available in:

Widths: 7'10" to 10'4" (single car) and 15'6" to 19" (double car)  
Heights: 6'0", 6'3", 6'6", 6'9", 7'0", 7'6", 7'9", 8'0"

Example of decorative face hardware placement.

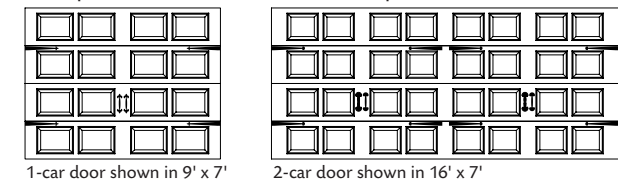

## Optional Decorative Face Hardware



Add character to your door with attractive decorative face hardware. The black matte powdercoated straps and handles are designed to appear hand-forged, adding a historically-accurate dimensional quality to your door. Choose from handles and 18" hinge straps with Bean or Fleur-de-lis designs.

# Openers

CONVENIENT AND RELIABLE



The in-vehicle universal remote control. See your automobile dealer for availability.

Raynor offers a full line of powerful, reliable, garage door openers that provide maximum security and convenience. Choose from 1/3 to 3/4 horsepower chain, belt and screw drive openers that feature advanced electronics and long-lasting performance year in and year out. With the best warranties in the industry, Raynor openers carry warranties varying from lifetime on motor to 1 year on components.

For super-quiet operation, select models featuring the Motor Vibration Isolation System, a revolutionary technology that is trouble-free, year after year. Designed to protect you and your family, safety and security features include the PosiLock™ Security System, adjustable light delay, Protector System® photoelectric eyes, and Safety Signal™ hand-held transmitters.

For more information on Raynor openers, find the authorized dealer nearest you at [www.raynor.com](http://www.raynor.com) or call 800-4-RAYNOR (472-9667).

# Professional Installation

D E P E N D   O N   Y O U R   R A Y N O R   D E A L E R



When you select Raynor, you're not just getting a superior garage door – you're also getting professional garage door installation and service expertise.

Every Raynor garage door is installed by a trained Raynor professional. And that means added benefits for you. First, you won't have to deal with it yourself. And because it's done right the first time, your door will deliver performance and reliability from the day it's installed.

Your technician will check your door for everything from safety to performance to appearance. Trust your Raynor garage door to someone who knows it better than anyone else – your professional Raynor Dealer.

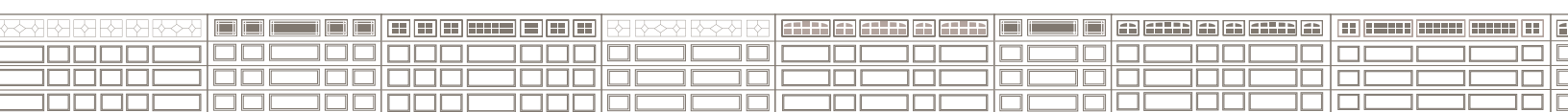

[www.raynor.com](http://www.raynor.com)

1-800-4-RAYNOR (472-9667)

Raynor Worldwide • P.O. Box 448, 1101 East River Road • Dixon, IL 61021-0448

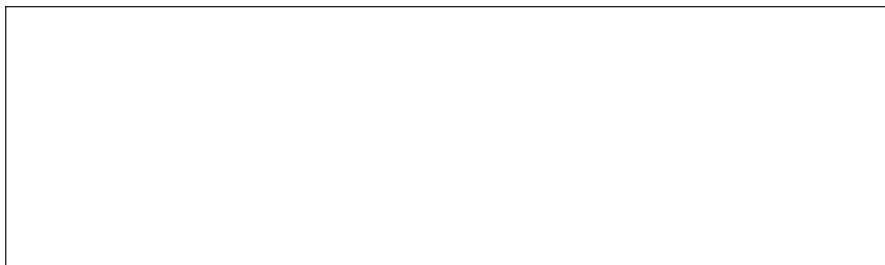

This information was as complete and factual as possible at the time it was printed. We do, however, reserve the right to make product changes in specifications and availability without notice. Product colors have been reproduced as well as possible with present commercial printing processes. For absolute accuracy in color matching, use actual product samples.

Features and options may be different in countries other than the United States. Kynar® is a registered trade name of Elf Arochem, NA.